



Modbus/RS-485



924MB Multi-Channel Temperature Control Modules

Thermocouple or Millivolt Input

Limit Alarms or Discrete Outputs

Model

924MB: 4 input channels

Input

Four input channels:
Thermocouple (types J, K, T, R, S, E, B, N),
±100mV DC

Output

Four output channels:
Open-drain MOSFETs (1A DC loads)
0 to 35V DC

Network Communication

Modbus-RTU high-speed RS-485

Power Requirement

10 to 36V DC,
24V AC

Approvals

CE marked. UL, cUL listed
Class I; Division 2; Groups A, B, C, D.

Thermocouple/Millivolt Input Module

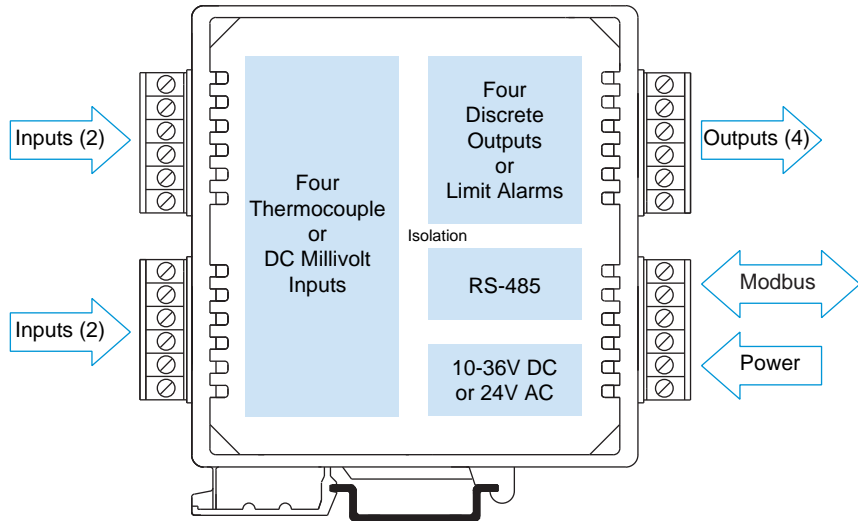

Description

This signal conditioner is a four-channel analog input module with four discrete outputs. It filters and linearizes thermocouple inputs while providing isolation between input, output, power, and network circuits. Cold junction compensation and upscale/downscale sensor break detection are standard. AC and DC power sources are supported with nonpolarized, diode-coupled terminals.

The programmable inputs accommodate eight thermocouple types plus wide-range millivolt signals. Flexible discrete outputs operate as alarms or on/off controllers. As limit alarms, each discrete output can be configured with high and/or low setpoints exclusively tied to an analog input channel. Alarm trips function without host communication enabling low-cost stand-alone alarms as well as local backup for the primary control system. Otherwise, on/off control is based on commands issued by the host system.

Combining flexible transmitter functions, mixed signal I/O, alarm support, and a network interface in a single package, makes this instrument extremely powerful. Multi-channel design adds cost-efficiency and allows high-density mounting. Plus, safe, rugged construction makes these modules reliable for use in both control room and distributed field I/O applications. Custom module configurations are also possible (consult factory for details).

Special Features

- Standard Modbus RTU protocol with high-speed RS-485 communication (up to 115K bps)
- 16-bit sigma-delta A/D yields 0.1°C resolution and 0.5°C measurement accuracy
- Thermocouple linearization and sensor break detection ensure reliable measurements
- Four discrete outputs enable local temperature limit alarms or host-controlled on/off switching
- Heavy-duty 1A solid-state relays provide dependable on/off control of industrial devices
- Self-calibration lowers maintenance costs by reducing periodic manual calibration checks
- Watchdog timers provide a configurable failsafe output state for use when host I/O communication is lost
- Four-way isolation eliminates potential ground loops between power, input, output and network circuitry
- Self-diagnostics monitor microcontroller activity to detect operational failures (lock-up) and execute a reset to restore communication



Performance

General Input

Resolution

±100mV DC input: 0.1%.
Thermocouple input: 0.1°C (0.18°F).

Ambient Temperature Effect

Better than ±0.005% of input span per °C, or ±1.0uV/°C, whichever is greater.

Noise Rejection

Normal mode: 40dB @ 60Hz, typical.
Common mode: 140dB @ 60Hz, typical.

Input Filter Bandwidth

-3dB at 3Hz, typical.

Input Conversion Rate

90ms per channel.

Thermocouple Input

Thermocouple Input Ranges

Thermocouple type user-configured. Type selected applies to all channels. Signal linearization, cold-junction compensation, and open circuit or lead break detection are included.

TC	°C Range (°F Range)	Accuracy
J	-210 to 760°C (-346 to 1400°F)	±0.5°C
K	-200 to 1372°C (-328 to 2502°F)	±0.5°C
T	-260 to 400°C (-436 to 752°F)	±0.5°C
R	-50 to 1768°C (-58 to 3214°F)	±1.0°C
S	-50 to 1768°C (-58 to 3214°F)	±1.0°C
E	-200 to 1000°C (-328 to 1832°F)	±0.5°C
B	260 to 1820°C (500 to 3308°F)	±1.0°C
N	-230 to 1300°C (-382 to 2372°F)	±1.0°C

Note 1: Accuracy is given with CJC switched off.

Relative inaccuracy with CJC enabled may increase by ±0.5°C.

Thermocouple Break Detection

TC sensor failure can be configured for either upscale or downscale. Selection applies to all channels.

DC Millivolt Input

Millivolt Input Ranges

±100mV DC.

Millivolt Input Accuracy

±0.1% of input range.

Discrete Output

Output Type

Four independent open drain MOSFET switches with a common return that operate as low-side switches.

Output Voltage Range

0 to 35V DC, 1A DC maximum for each output.
External voltage source required.

Output ON Resistance

0.15 ohms maximum.

Operation

Digital outputs are set to their OFF state following a software or power-on reset. Outputs can optionally be set to user-defined states following a watchdog timeout. Watchdog timeout output control takes precedence over limit alarm control. Alarm control takes precedence over host control.

Output Response Time

4.1ms typical, from receipt of command to gate transition of the output MOSFET.

Communication

Supported Modbus Commands

The command/response protocol for communicating with this module adheres to the Modbus/RTU standard for the following Modbus Functions.

- Read Coil
- Read Holding Registers
- Read Input Registers
- Force Single Coil
- Preset Single Register
- Force Multiple Coils
- Preset Multiple Registers
- Report Slave ID
- Reset Slave

LED Indicators

LEDs indicate power, status, and discrete level/alarm.

Power and Isolation

Power Requirements

10 to 36V DC,
22 to 26V AC.

Supply Current

Supply	Current Draw
10V DC	100mA maximum
24V DC	45mA maximum
24V AC	85mA rms maximum

Isolation

1500V AC for 60 seconds or 250V AC continuous.
4-way isolation between input, network, power and discrete I/O circuits. Inputs are isolated channel-to-channel for common mode voltage to ±5V DC.

Ordering Information

924MB-0900

Thermocouple/millivolt input module

900C-SIP

Configuration Software Interface Package (includes software CD-ROM for Windows, RS-232/485 converter, and RS-485/three-wire cable)

4001-095

USB-to-RS232 adapter. See page 70 for more info.

TBK-B01

Optional terminal block kit, barrier strip style, 2 pcs. (Does not include terminal block for input wiring.)

TBK-S02

Optional terminal block kit, spring clamp style, 2 pcs. (Does not include terminal block for input wiring.)

PS5R-VD24

Power supply (24V DC, 2.1A).
See Power Supplies on Page 199.

For more information on software, network hardware, and mounting accessories, please see Pages 69-71.

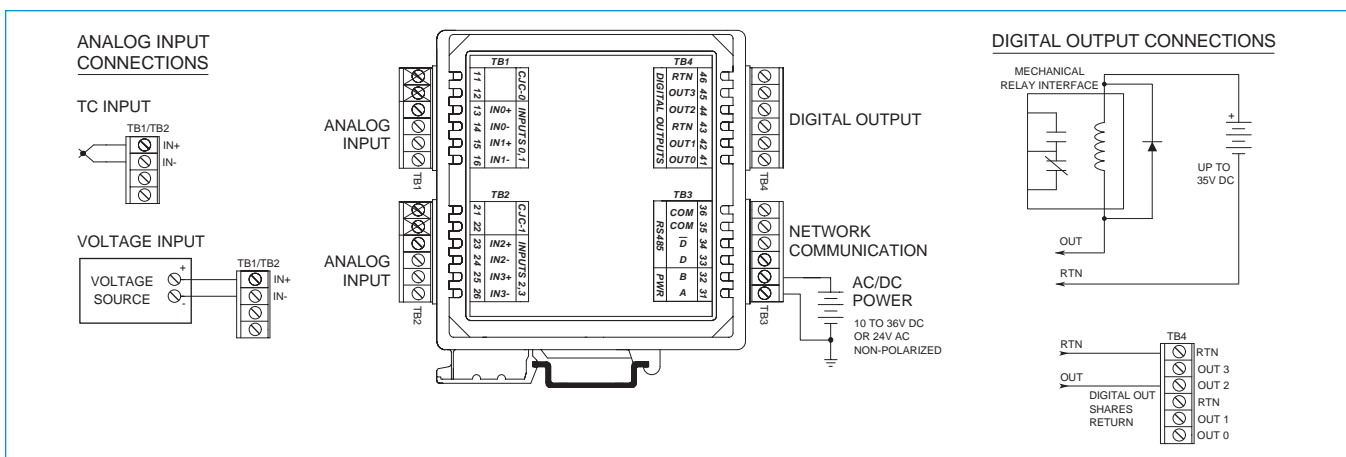



900MB Series Technical Diagrams

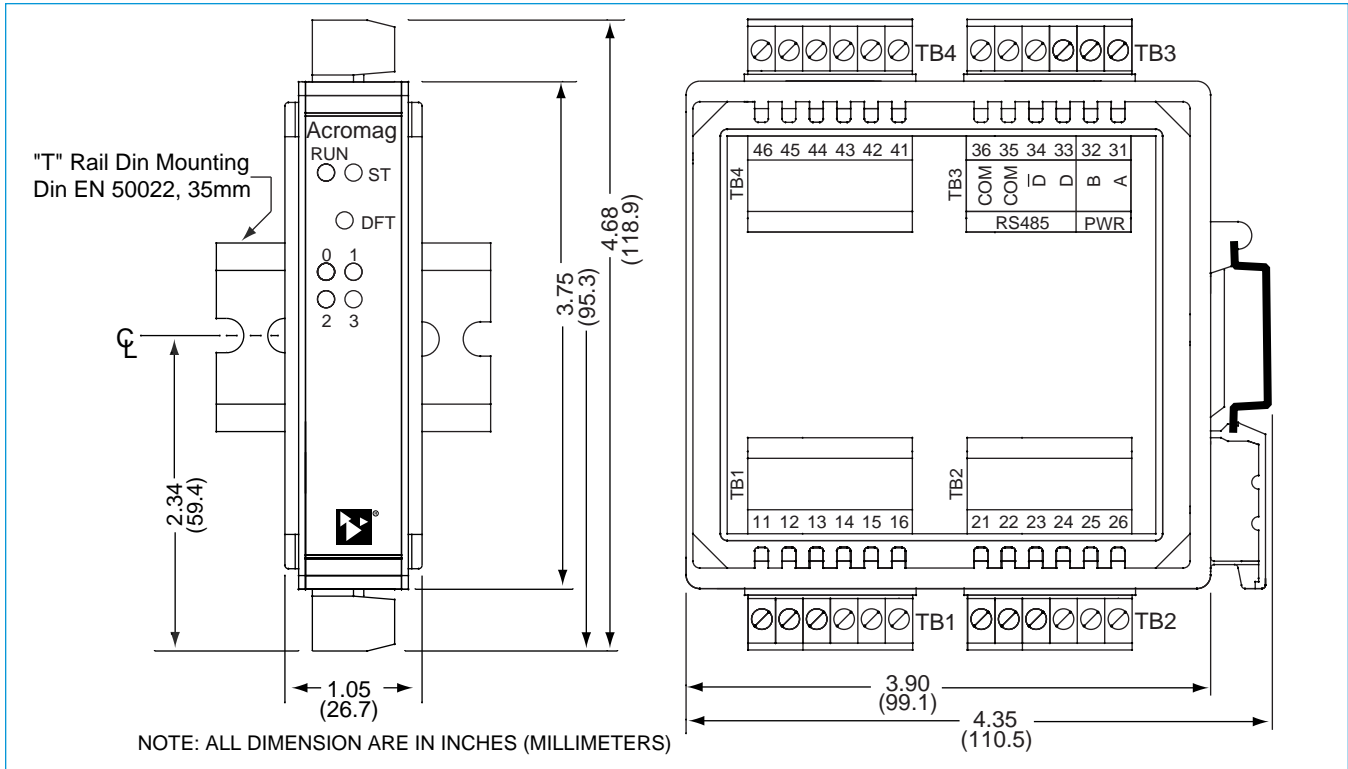

PERSONAL COMPUTER
W/ WINDOWS 95/98 OR NT

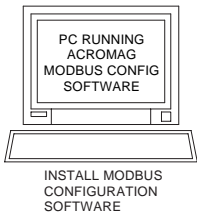

RS-232 SERIAL PORT CONNECTOR AT BACK OF PC

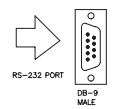

RS-232 TO RS-485 CONVERTER MODEL 5034-214

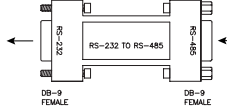

CABLE 5034-202

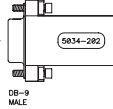

CAUTION: DO NOT CONNECT THE CABLE DIRECTLY TO THE PC WITHOUT THE CONVERTER, OR DAMAGE TO THE MODULE MAY RESULT.

900C-SIP COMMUNICATION CONNECTIONS

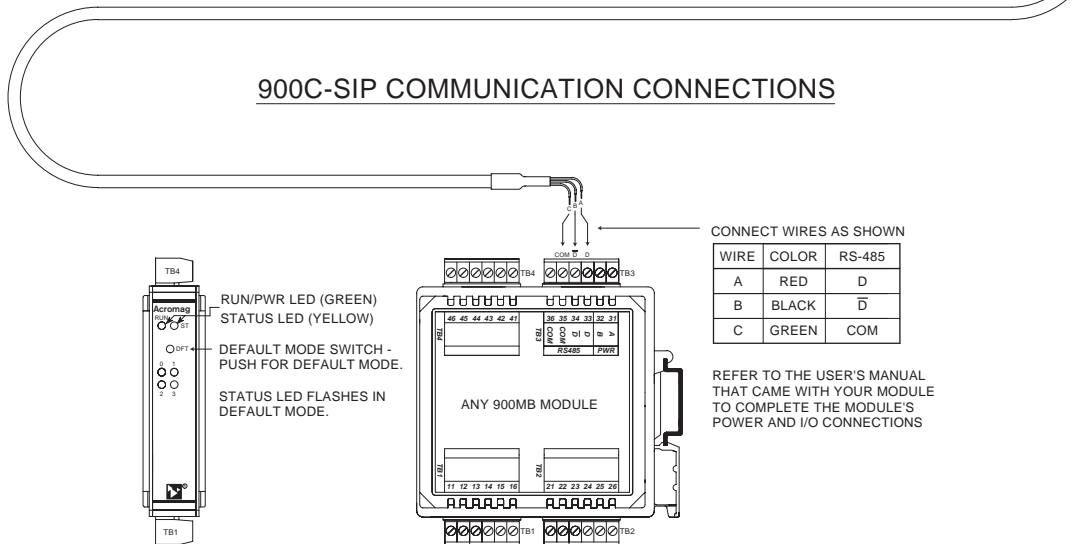



Configuration Kit

Software Interface Package
Model No. 900C-SIP

RS-485 Cable (DB-9)

RS-232 to RS-485 Converter (non-isolated)

Configuration Software for Windows

Software Interface Package

This package includes Windows® Configuration Software, an RS-232-to-485 Serial Port Converter, and an RS-485 Signal Cable. These components provide everything you need to set up a Series 900 I/O module from your desktop PC before installing it on the network.

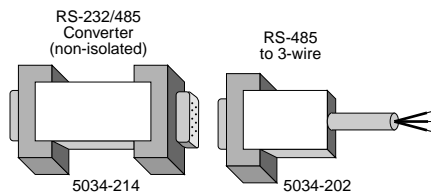

Ordering Information

- 900C-SIP
Software Interface Package.
Includes Configuration Software (5034-186), Non-isolated RS-232 to RS-485 Serial Port Converter (5034-214), and RS-485 Cable (5034-202).
Items can also be ordered separately below.
- 5034-186
Configuration Software for Windows (95/98/2000/ME/NT4/XP) on CD-ROM.
- 5034-214
Non-isolated RS-232 to RS-485 Serial Port Converter, DB-9F to DB-9F.
- 5034-202
RS-485 to 3-wire Cable Converter, DB-9M to 3 x 12AWG RS-485 Cable, 8 ft.

Network Power

PS5R-VD24
Universal Power Supply

50W
DC ON
V.ADJ.

INPUT: 80-300V 100-240VAC 1.5A

OUTPUT: 24VDC 2.1A

CE, UL LISTED, TUV

Universal 50W Power Supply

The PS5R-VD24 is the ideal power source to drive your network.

Input Power Requirement
Universal power
85 to 264V AC,
105 to 370V DC

Output
24V DC, 2.1A (50W)

Ordering Information

PS5R-VD24
Universal Power Supply

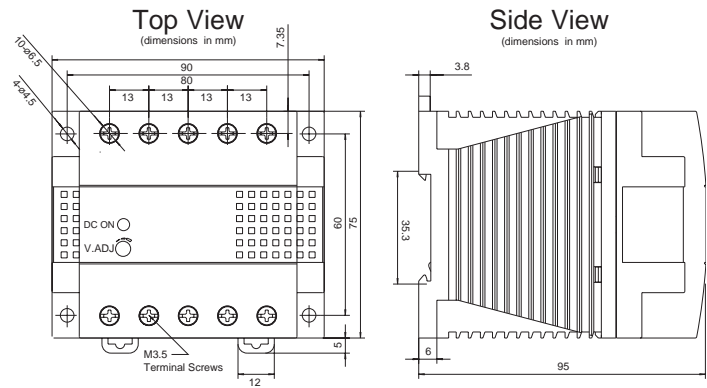

Mounting Hardware

DIN-Rail Mounting

For your convenience, Acromag offers several mounting accessories to simplify your system installation. Our 19" rack-mount kit provides a clean solution for mounting your I/O modules and a power supply. Or you can buy precut DIN rail strips for mounting on any flat surface.

Ordering Information

- 20RM-16-DIN
19" rack-mount kit with DIN rail.
- DIN RAIL 3.0
DIN RAIL 16.7
DIN rail strip, Type T, 3 inches (75mm) or 16.7 inches (425mm)

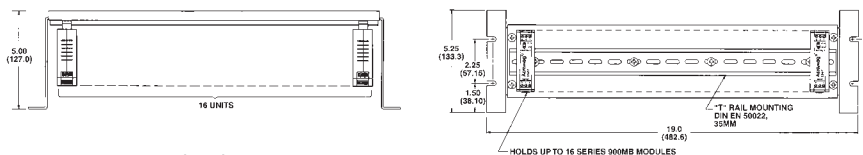

Model 4001-095 USB-to-Serial Adapter

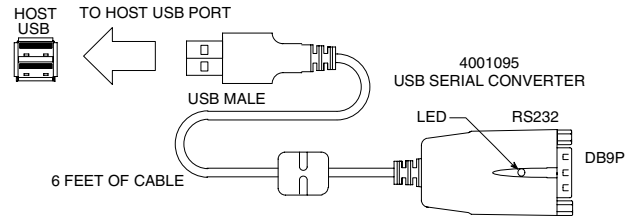
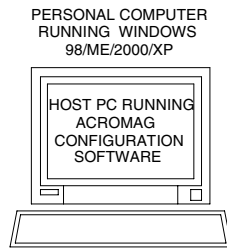

Simplifies configuration of Acromag I/O Modules ♦ Enables configuration via USB port

Description

This device is a USB-to-serial adapter that you can use to communicate with many Acromag I/O products for setup and re-configuration for your application.

Key Features & Benefits

- Connects to I/O modules via USB (other adapters may be necessary)
- Complete RS232 control signals
- Conforms to USB Specification, Version 1.1
- USB-powered
- Cable length, 6 ft., UL approved

Performance Specifications

USB Specification
Version 1.1

Data rate
Up to 115.2Kbps

Environmental Standards
RoHS-compliant

Basic Power Consumption
150mA

PC Requirements
Windows® 7 (32-/64-bit) / Vista (32-/64-bit) / XP (32-/64-bit) / Server 2003 & 2008 (32-/64-bit) / 2000 / ME / 98SE / 98

Ordering Information

NOTE: For more information visit www.acromag.com.

Adapters

- 4001-095**
USB to serial adapter. Includes driver CD and manual.
- 5030-913**
Serial port adapter. DB9S connector to RJ11 jack.
- 5034-202**
RS-485 to 3-wire cable converter and cable, DB-9M to 3 x 12AWG RS-485 cable, 8 ft.
- 5032-287**
RS-232 to 151T transmitter configuration device converter and cable, 6 ft.
- 5034-214**
Non-isolated RS-232 to RS-485 Serial Port Converter, DB-9F to DB-9F.

Cables

- 5030-902**
Cable. 6 feet long with RJ11 plug at each end.

IntelliPack 800x Series Adapter and Cable

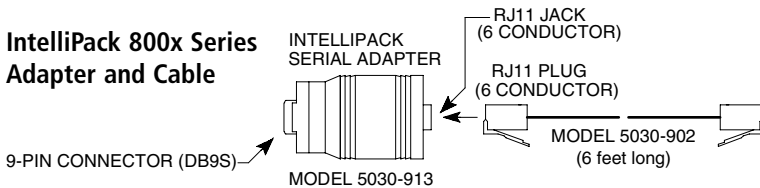

900MB Modbus Series Adapter and Cable

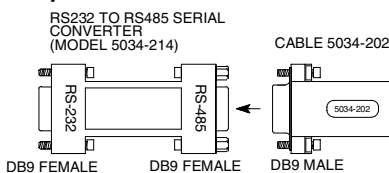

151T Transmitter Series Adapter and Cable

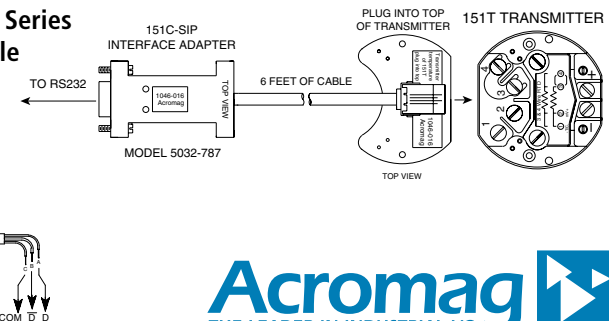

Tel: 248-295-0880 ■ Fax: 248-624-9234 ■ sales@acromag.com ■ www.acromag.com ■ 30765 S Wixom Rd, Wixom, MI 48393 USA